

HSA PV 800 M

- Surge arresters type T2 intended for photovoltaic systems (PV) at U or Y connection.
- The advantage of the Y connection versus the U connection is the resistance to the earth connection of the working conductors and zero residual (leakage) current through the PE conductor.
- Particular varistor sectors, connected between the terminals L+, L- and PE are equipped with internal disconnectors, which are activated when the varistors fail (overheat) and they are able to interrupt the DC current.
- Special construction of the internal disconnector allows installation without a back-up fuse.
- They are installed on the DC side in PV applications without an external LPS or with an external LPS, where the sufficient distance "s" is observed.
- Suitable for all LPL levels.
- Ensure the equipotential bonding of positive and negative busbars of PV systems and the elimination of transient overvoltage that originates during the atmospheric discharges or switching processes.
- **M** indication specifies a type of construction with removable module.
- **S** indication specifies a version with remote monitoring.

Type		HSA PV 800 M
Test class according to EN 61643-11:2012 and EN 61643-31:2019		T2
System		DC
PV system type		Ungrounded
SPD connection type		Y
Maximum continuous operating voltage (+/-)	U_{CPV}	800 V DC
Maximum continuous operating voltage (\pm/PE)	U_{CPV}	800 V DC
Max. voltage of PV generator $U_{OCSTC} \leq U_{CPV} / 1.2$	U_{OCSTC}	665 V
Short-circuit current rating	I_{SCPV}	10 kA
Total discharge current (8/20) $\pm \rightarrow PE$	I_{Total}	40 kA
Maximum discharge current (8/20)	I_{max}	40 kA
Nominal discharge current for class II test (8/20)	I_n	20 kA
Voltage protection level at I_n (+/-)	U_p	< 3.3 kV
Voltage protection level at I_n (\pm/PE)	U_p	< 2.1 kV
Response time (+/-)	t_A	< 25 ns
Response time (\pm/PE)	t_A	< 100 ns
Housing material		Polyamid PA6, UL94 V-0
Degree of protection		IP20
Operating temperature	θ	-40 ÷ 70 °C
Humidity range	RH	5 ÷ 95 %
Minimum cross-section of connected Cu conductors according to IEC 61643-32:2017 (doesn't apply to „V“ connection) for T2	S	2.5 mm ² (L+, L-) 6 mm ² (PE)
Clamp fastening range (solid conductor)		2.5 ÷ 35 mm ²
Clamp fastening range (stranded conductor)		2.5 ÷ 25 mm ²
Tightening moment		4 Nm
Installation		On DIN rail 35 mm
Modular width		3 TE

Type		HSA PV 800 M
Operating position		Any
Product placement environment		Internal
SPD failure mode		OCFM
Signalling at the device		Optic
Importance of local signaling		OK – green target FAULT – red target
Remote signalling		No
Modular design		Yes
Article number of the varistor spare module		27 258
Article number of the gas discharge tube spare module		30 072
Lifetime		> 100 000 h
Designed according to standards		
Requirements and test methods for SPDs for photovoltaic installations		IEC 61643-31:2018
Safety of Flammability of Plastic Materials		UL 94
Application standards		
Protection against lightning		IEC 62305:2010
Selection and application principles for SPDs connected to photovoltaic installations		IEC 61643-32:2017
Selection and application principles for SPDs connected to photovoltaic installations		CLC/TS 51643-32:2020
Low-voltage electrical installations – Photovoltaic (PV) systems		HD 60364-7-712:2016
Ordering, packaging and additional data		
Mass	m	396 g
Mass (including the packaging)	m	415 g
Packaging dimensions (H x W x D)		60 x 111 x 87 mm
Packaging value	V	0.58 dm ³
ETIM group		EG000021
ETIM class		EC000941
Customs tariff no.		85363010
EAN code		8590681187326
Art. number		27 254



The link in the QR code leads to the online presentation of the **HSA PV 800 M**. There, in addition to the always up-to-date data sheet, you will also find all diagrams and drawings, declarations of conformity, or 2D or 3D models and other necessary materials. For more information, visit www.hakil.com



8590681187326

Application wiring diagram (installation)

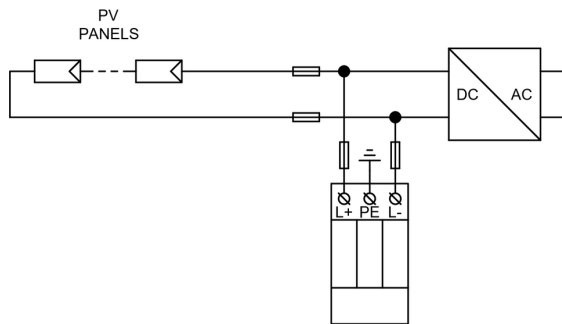

Internal diagram

